

SPO

SPO SERIES SINGLE POINT LOAD CELLS



Load cells for off center loads, suitable for example to build CE-M approved scales with a single load cell with maximum dimensions of 300x300 mm.

CAPACITIES (kg): 3, 5, 10, 15, 20, 30, 40.

OIML R60. C3 precision class.

Aluminium alloy. **IP67** protection.

The best solution
for advanced industrial
applications

MAIN FEATURES

- C3 PRECISION CLASS
- OFF CENTER LOAD COMPENSATED
- ALUMINIUM ALLOY CONSTRUCTION
- IP67 PROTECTION
- MAX. CAPACITIES FROM 3 TO 40 kg
- FOR PLATFORMS WITH DIMENSIONS UP TO 300 X 300 mm
- SHIELDED CONNECTION CABLE
- OIML AND TEST CERTIFICATES AVAILABLE UPON REQUEST

TECHNICAL FEATURES

- Minimum load cell verification interval: $V_{min} = E_{Max}/15.000$
- Maximum number of verification intervals: $n_{LC} = 3000$
- Full Scale Output: $2mV/V \pm 10\%$
- Temperature effect on zero: $0,01\% FS/10K$
- Temperature effect on full scale output: $0,001\%FS /10K$
- Compensated Temperature Range: $-10^{\circ}C/+40^{\circ}C$
- Operating Temperature Range: $-10^{\circ}C/+50^{\circ}C$
- Creep error after 30 minutes: $0,01\% F.S$
- Maximum tolerated excitation voltage: 15 VDC
- Input Resistance: 300..500 Ohm
- Output Resistance: 300..500 Ohm
- Insulation Resistance: $>2000 MOhm$
- Safe Overload: 150% F.S.
- Ultimate Overload: 300% F.S.
- 4-wire shielded cable, 40cm long, 3,2mm diameter

ATEX Version

- The CCATEX certificate makes the load cell suitable for use in hazardous areas with protection methods according to:
ATEX II 1G Ex ia IIC T6 (Ta $-20\div+40^{\circ}C$) TX (Ta $-20\div+65^{\circ}C$) Ga
ATEX II 1D Ex ta IIIC TX $^{\circ}C$ (Ta $-20\div+40^{\circ}C$) TX $^{\circ}C$ (Ta $-20\div+65^{\circ}C$) Da IP65.
The certificate includes the manual and the ATEX CE conformity declaration (available in EN, DE, FR, and IT).
- **IMPORTANT:** the certificate refers to the single load cell. For systems with more load cells, it is necessary to order one certificate for each load cell.

DETAIL 1

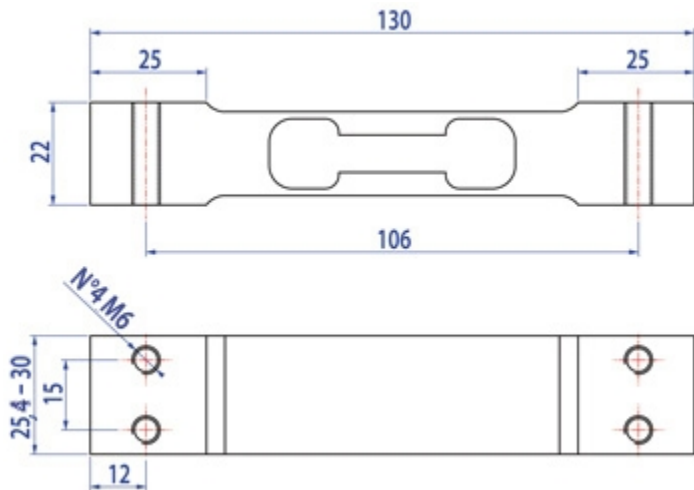







Dimensions in mm

<u>Wiring Code</u>	
<u>Color</u>	<u>Function</u>
YELLOW	SHIELD
WHITE	OUTPUT +
BLUE	INPUT +
RED	OUTPUT -
BLA	INPUT -

VERSIONS

Available versions

Codice	Piatto Max (mm)	Max (kg)
SPO3 	150x150	3
SPO5 	300x300	5
SPO10 	300x300	10
SPO15 	300x300	15
SPO20 	300x300	20
SPO30 	300x300	30
SPO40 	300x300	40

COVENTRY SCALE COMPANY



COVENTRY SCALE COMPANY LTD

BARKERS BUTTS LANE 137 - CV61EB - COVENTRY - UNITED KINGDOM

Tel. 0044-2476-593500

Fax. 044-2476-601239

E-mail info@coventryscale.co.uk

Web www.coventryscale.co.uk